



## GD200A Series General Purpose Vector Control Drive Product Introduction

GD200A series high performance general vector inverter, positioned as a new generation general purpose inverter; products using DSP control system and vector V/F control technology, with excellent motor drive performance and various protecting functions, widely used in air compressor, plastic machine, petroleum industry, coal industry, HVAC applications, fan pump and other standard transmission load.

## Product Advantage

- High performance
- Multi-function with simple operation
- Reliable quality certificated



## High Performance

### • More Accurate Motor Autotuning

Accurate rotating and static motor autotuning  
Convenient debugging and easy operation

Rotating autotuning	Static autotuning
De-couple from the load Applied to the situation with high control accuracy	No need to de-couple from the load Applied when rotating autotuning is not available

### • Advanced open loop vector control

The current, torque and rotating speed waveforms when sudden loading or unloading in asynchronous motor open loop vector control mode with 0.5Hz running frequency and full load.

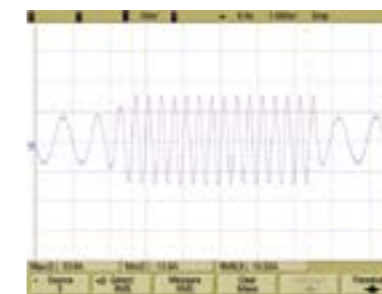

Current

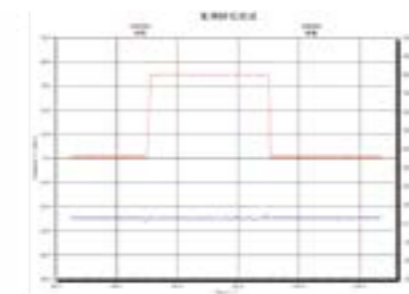

Torque & Rotating speed

### • Perfect voltage and current control, reducing the fault protection times

**OC fault** Adjust the output frequency to avoid overcurrent of the inverter during acceleration

**OV fault** Adjust the output frequency to avoid overvoltage of the DC bus during deceleration

### • Multiple braking modes and instant stopping

**Dynamic braking**

- Configure braking units and resistors
- Available on the situation of big inertia load and frequent braking
- Big braking torque and quick braking

**DC braking**

- No need to configure braking units and resistors
- Available on the situation when start the running motor after braking and the situation when keep the moment output after braking to zero speed
- Not available on the situation of big inertia load or instant stopping braking in high speed running

**Flux braking**

- No need to configure braking units and resistors
- Available on the instant stopping situation with big inertia load and no frequent braking
- Not available on the situation of big inertia load and frequent braking (the energy consumed on the stator and its cooling is better than DC braking)

**Short circuit braking**

- No need to configure braking units and resistors, capable of braking quickly
- Applicable to the motors at quick start and stop or restart after braking
- Not applicable to big inertia load and frequent braking

# Multi-Function with Simple Operation

## Separate Air-duct

The separate air duct prevents the contaminants into the electronic parts/components and greatly improves the protective effect of the inverter, as well as its reliability and service life, to adapt various complicated site environments. It can also facilitate the heat-releasing in control cabinets and the heat-releasing design of the customer.

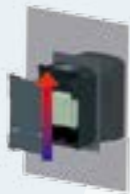

## Multiple installation modes

0.75~200kW: Wall mounting and flange mounting  
200~315kW: Wall mounting and floor mounting  
350~500kW: Floor mounting  
Remark: above power ratings are subject to G type machine.



## Standard built-in C3 input filters, optional external C2 filters

C3 input filter is embedded in the factory to meet different application requirements, save installation space and avoid electromagnetic interference caused by incorrect selection and site installation.

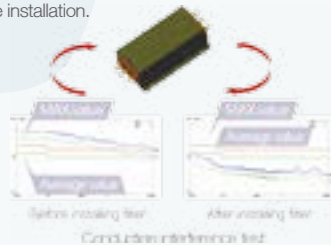

Remarks:  
C2 filter: EMC performance of the inverter achieves the limited usage requirement in civil environment.  
C3 filter: EMC performance of the inverter achieves the limited usage requirement in civil environment.

## Book structure

Parallel installation  
Smaller installation space with less cost and beautiful appearance.



## The rivet design ensures reliable integration connection

Greener Proper grounding  
Stronger corrosion-resistance Excellent EMC performance



## Smaller Size

Due to the thermal simulation and advanced modularized design, the size of our product is reduced greatly. The width ratio between Goodrive300 and CHF100A is shown in the figure below (the Max. percentage is 50%)



## GD200A series

Membrane keypad design (which can be connected to external keypads) is available for inverters ( $\leq 15\text{kW}$ ); swappable keypads are standard for inverters ( $\geq 18.5\text{kW}$ )



Terminals	Quantity	Features
ON-OFF input	8 channels	1KHz NPN and PNP
High speed	0.75	9.3
Pulse input	1 channel	50KHz NPN and PNP
Analog input	2 channels	0~10V, 0~20mA, -10V~+10V
ON-OFF output	1 channel	Max. output frequency: 1KHz
High speed	1.5	5.0
Pulse output	1 channel	Max. output frequency: 50KHz
Analog output	2 channels	0~10V, 0~20mA
Relay output	2 channels	3A/250DAC, 1A/30VDC, NO+NC

## High Performance Keypad

External LED keypads are standard for inverters ( $\geq 18.5\text{kW}$ ) to support parameters upload and download, the maximum external length is 200M and the keypads have digital potentiometers; external keypads are optional for inverters ( $\leq 15\text{kW}$ ).



The optional external LCD keypad supports parameters loading and unloading with English.

## Available on DC power supply

Reduce the occupied space and decrease the cost of the customer.



## Embedded braking units of 0.75-30kW inverters

Reduce the occupied space and decrease the cost of the customer.

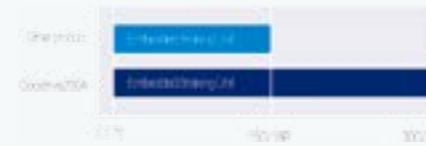

## Supporting common DC bus

Reduce the power lost on DBR  
Note the impact current and the capacity of the input AC system



## Function of water supply

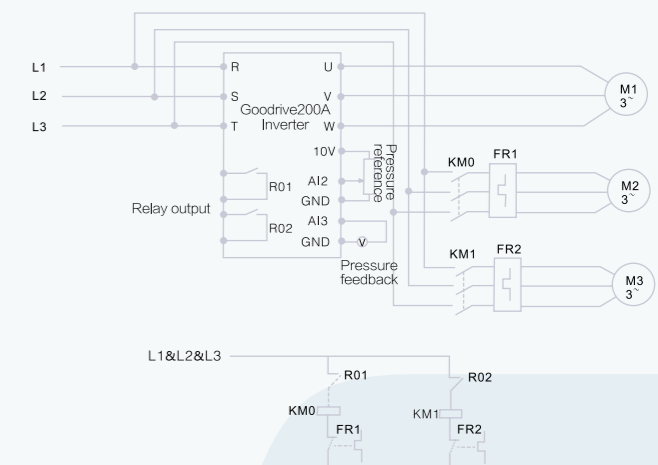

In the diagram above, M2 and M3 are auxiliary motors which are controlled by R01 and R02. PID constant-pressure automatic control system is formed by the inverter through pressure feedback. The pressure reference can apply analog or keypad input. 485 remote communications is also supported.

## The product design follows IEC national standards and passes the CE test certification.



Remarks:  
Each Goodrive200A inverter has past the test certification

- Advanced thermal technology makes exact thermal design
- Wide voltage range meets the requirement of grid environment

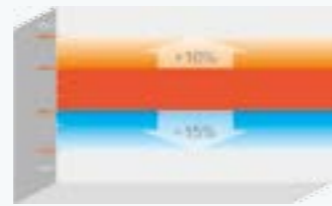

AC 3PH:380V(-15%)-440V(+10%) Wide voltage range

- Perfect and reliable test system ensure products adapt complicated site environments

Experiment type	Experiment name	Classification	
Mechanical reliability experiments	Package experiments	Package compression experiments	
		Package resonance imaging and storage test	
		Package random vibration test	
		Package dropping test	
		Package rolling test	
		Package dumping test	
	Impact test	Half-sine wave impulse test(non-working state)	
		Trapezoidal wave impulse test (non-working state)	
	Vibration test	Sinusoidal vibration test (working state)	
Random vibration test (working and non-working state)			
Climatic environmental reliability test	Low temperature storage test		
Climatic environmental reliability test	Temperature experiment	High temperature storage test	
		Low temperature experiments	
		High temperature experiments	
		Temperature gradient experiments	
		Temperature impact test	
	Thermal test	Constant thermal test	
		Alternation thermal test	
	Salt spray test	Constant salt spray test	
		Alternation salt spray test	
	Low air pressure test	Low Air Pressure Test	
		Low temperature and low pressure test	
			High temperature and low pressure test

Remarks:  
INVT is the only manufacturer achieved ACT certificate of TÜV SÜD .The full name of ACT is Acceptance of Client's Testing, which means the German TÜV SÜD admit the technology level of the lab and accept their separate testing data and test reports officially.



Electric Vibration System



Low Pressure Test Chamber (L)  
Constant Temperature and Humidity Test Chamber (R)



Natural Convection Test Chamber (L)  
Thermal Shock Test Chamber (R)

## Main Applications



Air compressor



Oil industry



Warming and water supply



Plastics machine



Mining



Fans and water pumps

# Technical Specifications

	Function	Illustration
Input	Input voltage (V)	AC 3PH 400V±15%
	Input current (A)	Refer to the rated value
	Input frequency (Hz)	50Hz or 60Hz Allowed range: 47~63Hz
Output	Output voltage (V)	0~input voltage
	Output frequency (Hz)	0~400Hz
Technical control feature	Control mode	V/F
	Motor type	Asynchronous motor
	Speed ratio	Asynchronous motor 1:100
	Overload capability	G type: 150% of rated current: 1 minute 180% of rated current: 10 seconds 200% of rated current: 1 second P type: 120% of rated current: 60 second
	Torque overload capacity	G type: 150% for machines 180 % for quick response machines P type: 120% for pump and fan
Running control feature	Frequency setting	Digital setting, analog setting, pulse frequency setting, multi-step speed running setting, simple PLC setting, PID setting, MODBUS communication setting, PROFIBUS communication setting. Realize the shifting between the set combination and set channel.
	Auto voltage adjustment	Keep a stable voltage automatically when the grid voltage transients
	Fault protection	Provide over 30 fault protection functions: overcurrent, overvoltage, undervoltage, overheating, phase loss and overload, etc.
	Speed tracking	Restart the rotating motor smoothly
Peripheral interface	Terminal analog input resolution	≤10mV
	Terminal switch input resolution	≤ 2ms
	Analog input	2 channels (AI1, AI2) 0~10V/0~20mA and 1 channel (AI3) -10~10V
	Analog output	2 channels (AO1, AO2) 0~10V /0~20mA
	Digital input	8 channels common input, the Max. frequency: 1kHz 1 channel high speed input, the Max. frequency: 50kHz
	Digital output	1 channel high speed pulse output, the Max. frequency: 50kHz; 1 channel Y terminal open collector pole output
Relay output		2 channels programmable relay output RO1A NO, RO1B NC, RO1C common terminal RO2A NO, RO2B NC, RO2C common terminal Contactor capability: 3A/AC250V,1A/DC30V
	Mountable method	Wall, flange and floor mountable
Others	Temperature of the running environment	-10~50°C, derate above 40°C
	Ingress protection	IP20
	Cooling	Air-cooling
	Braking unit	Built-in braking unit for below 30G/37P (including 30G/37P) External braking unit for others
	Braking resistor	External braking
	EMC filter	Optional built-in C3 filter: meet the degree requirement of IEC61800-3 C3 Optional external filter ,meet the degree requirement of IEC61800-3 C2

# Standard Wiring

Wiring diagram of the main circuit

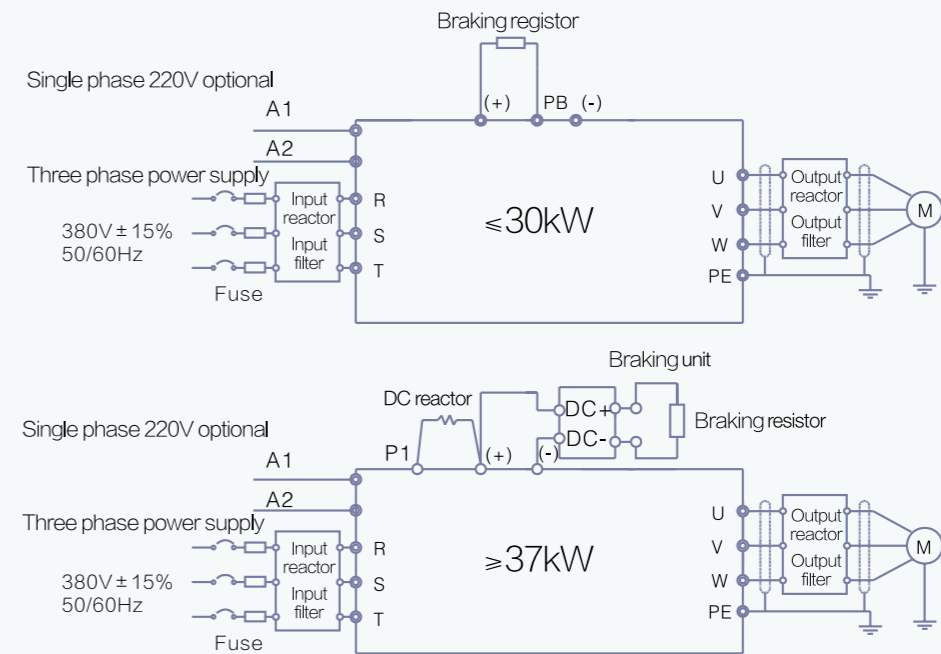

Wiring diagram of the control board

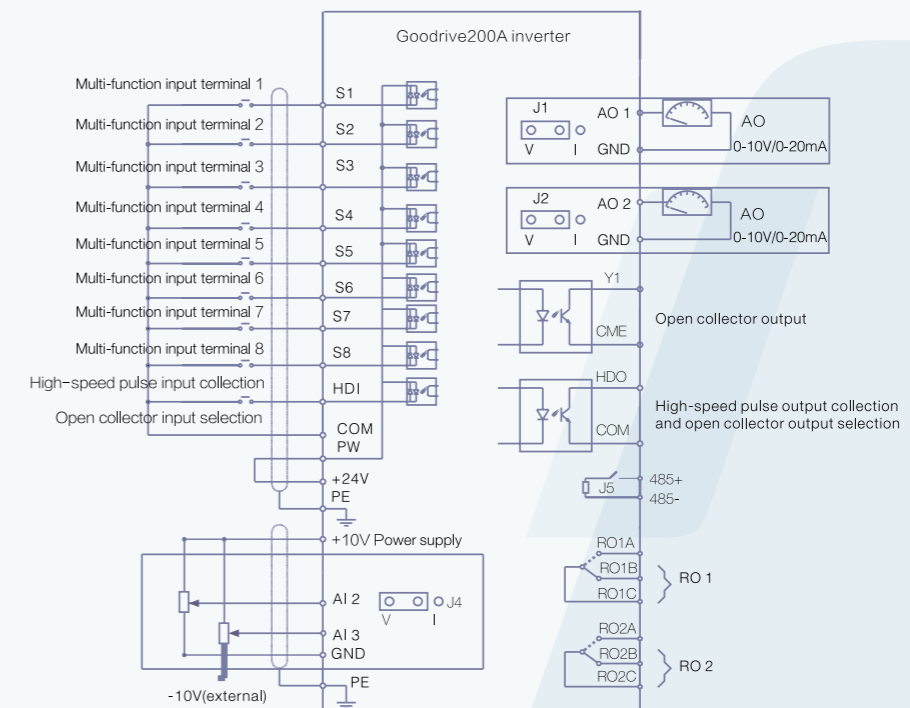

# Type Selection

## Power ratings And Dimension

Inverter model	Rated output power (kW)	Input current (A)	Rated output current (A)	Gross weight (Kg)	Dimension (mm)
3-phase 220VAC±15%					
GD200A-0R75G-2	0.75	5	4.5	4.1kg	360x250x265
GD200A-1R5G-2	1.5	7.7	7		
GD200A-2R2G-2	2.2	11	10		
GD200A-004G-2	3.7	17	16	7.4kg	445x295x320
GD200A-5R5G-2	5.5	21	20		
GD200A-7R5G-2	7.5	31	30		
GD200A-011G-2	11	43	42	11kg	550x375x375
GD200A-015G-2	15	56	55		
GD200A-018G-2	18.5	71	70		
GD200A-022GP-2	22	81	80	32kg	695x410x470
GD200A-030G-2	30	112	110		
GD200A-037G-2	37	132	130		
GD200A-045G-2	45	163	160	67kg	760x445x580
GD200A-055G-2	55	181	190		
3-phase 380VAC±15%					
GD200A-0R75G-4	0.75	3.4	2.5	2.5kg	275 x205 x235
GD200A-1R5G-4	1.5	5.0	3.7		
GD200A-2R2G-4	2.2	5.8	5		
GD200A-004G/5R5P-4	4/5.5	13.5/19.5	9.5/14	4.1kg	360 x250 x265
GD200A-5R5G/7R5P-4	5.5/7.5	19.5/25	14/18.5		
GD200A-7R5G/011P-4	7.5/11	25/32	18.5/25		
GD200A-011G/015P-4	11/15	32/40	25/32	7.4kg	445 x295 x320
GD200A-015G/018P-4	15/18.5	40/47	32/38		
GD200A-018G/022P-4	18.5/22	47/56	38/45		
GD200A-022G/030P-4	22/30	56/56	45/60	9kg	460 x340 x330
GD200A-030G/037P-4	30/37	70/80	60/75		
GD200A-037G/045P-4	37/45	80/94	75/92		
GD200A-045G/055P-4	45/55	94/128	92/115	32kg	695 x410x470
GD200A-055G/075P-4	55/75	128/160	115/150		
GD200A-075G/090P-4	75/90	160/190	150/180		
GD200A-090G/110P-4	90/110	190/225	180/215	67kg	760 x445 x580
GD200A-110G/132P-4	110/132	225/265	215/260		
GD200A-132G/160P-4	132/160	265/310	260/305		
GD200A-160G/200P-4	160/200	310/385	305/380	110kg	971 x631 x565
GD200A-200G/220P-4	200/220	385/430	380/425		
GD200A-220G/250P-4	220/250	430/485	425/480		
GD200A-250G/280P-4	250/280	485/545	480/530	165kg	1086x826x595
GD200A-280G/315P-4	280/315	545/610	530/600		
GD200A-315G/350P-4	315/350	610/625	600/650		
GD200A-350G/400P-4	350/400	625/715	650/720	450kg	1850x840x820
GD200A-400G-4	400	715	720		
GD200A-500G-4	500	890	860		

Remarks:  
 (1)The input current of the inverter 0.75G-315G/350P is tested when the input voltage is 380V and there is no DC reactor and output/input reactor.  
 (2)The current of the inverter 350G/400P-500G is tested when the input voltage is 380V and there is input reactor.  
 (3)Rated output current is defined when the rated output voltage is 380V.

# Installation Dimension

## Installation dimension when wall mounting

Installation dimension (unit: mm)

Model	W1	W2	H1	H2	D1	Installation holes	
3-phase 220VAC Series	0.75kW~2.2kW	146	131	256	243.5	181	6
	4kW~7.5kW	170	151	320	303.5	216	6
	11kW~15kW	255	237	407	384	245	7
	18.5kW~30kW	270	130	555	540	325	7
	37kW~55kW	325	200	680	661	365	9.5
3-phase 380VAC Series	0.75kW~2.2kW	126	115	186	175	174.5	5
	4kW~5.5kW	146	131	256	243.5	181	6
	7.5kW~15kW	170	151	320	303.5	216	6
	18.5kW	230	210	342	311	216	6
	22kW~30kW	255	237	407	384	245	7
	37kW~55kW	270	130	555	540	325	7
	75kW~110kW	325	200	680	661	365	9.5
	132kW~200kW	500	180	870	850	360	11
220kW~315kW	680	230	960	926	379.5	13	

## Installation dimension when flange mounting

Installation dimension (unit: mm)

Inverter model	W1	W1	W3	W4	H1	H2	H3	H4	D1	D2	Installation holes	
3-phase 220VAC series	0.75kW~2.2kW	170.2	131	150	9.5	292	276	260	6	167	84.5	6
	4kW~7.5kW	191.2	151	174	11.5	370	351	324	15	196.3	113	6
	11kW~15kW	275	237	259	11	445	426	404	10	245	119	7
	18.5kW~30kW	270	130	261	11	445	426	404	10	245	119	7
	37kW~55kW	325	200	317	58.5	680	661	626	23	363	182	9.5
3-phase 380VAC series	0.75kW~2.2kW	150.2	115	130	7.5	234	220	190	13.5	155	65.5	5
	4kW~5.5kW	170.2	131	150	9.5	292	276	260	6	167	84.5	6
	7.5kW~15kW	191.2	151	174	11.5	370	351	324	15	196.3	113	6
	18.5kW	250	210	234	12	375	356	334	10	216	108	6
	22kW~30kW	275	237	259	11	445	426	404	10	245	119	7
	37kW~55kW	270	130	261	11	445	426	404	10	245	119	7
	75kW~110kW	325	200	317	58.5	680	661	626	23	363	182	9.5
132kW~200kW	500	180	480	60	870	850	796	37	358	178.5	11	

## Installation dimension when floor mounting

Installation dimension (unit: mm)

Inverter model	W1	W1	W3	W4	H1	H2	D1	D2	Installation holes
220kW~315W	750	230	714	680	1410	1390	380	150	13\12
350kW~500kW	620	230	553	-	1700	1678	560	240	22\12

# Installation Diagram

- 3-phase 220VAC Series  
Wall Mounting for 0.75-55kW Inverters

0.75-7.5kW Installation diagram

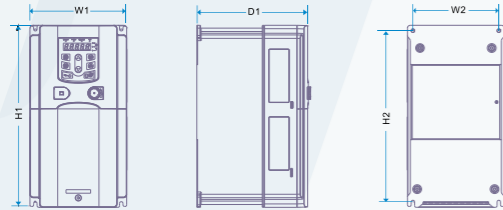

11-15kW Installation diagram

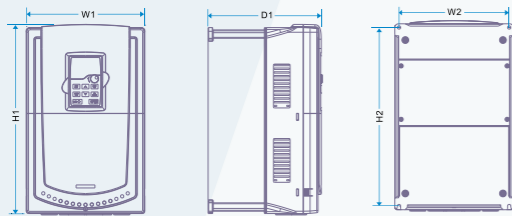

18-55kW Installation diagram

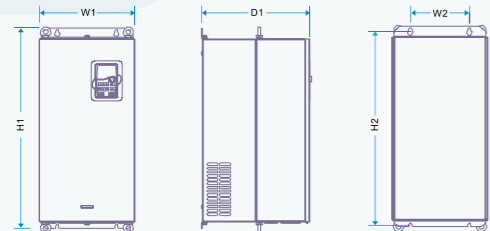

- 3-phase 380VAC Series  
Wall Mounting for 0.75-315kW Inverters

0.75-15kW Wall mounting Installation diagram

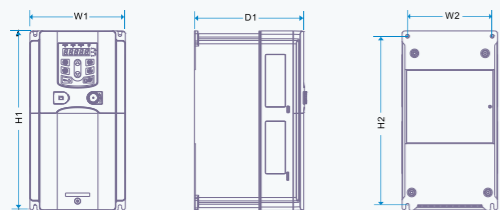

18.5-30kW Wall mounting Installation diagram

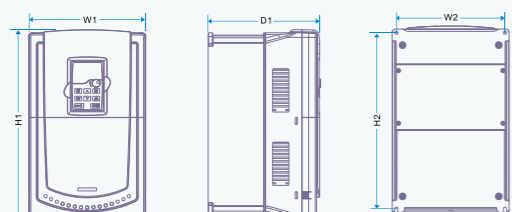

37-110kW Wall mounting Installation diagram

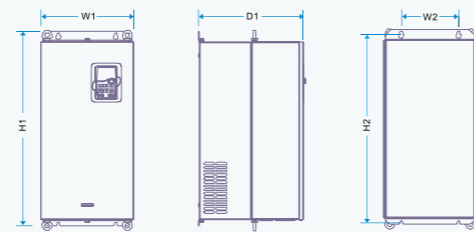

132-200kW Wall mounting Installation diagram

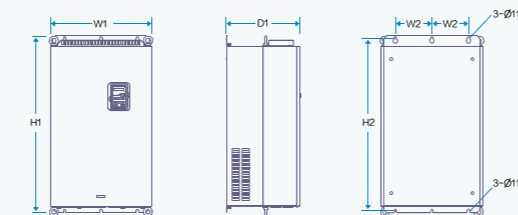

220-350kW Wall mounting Installation diagram

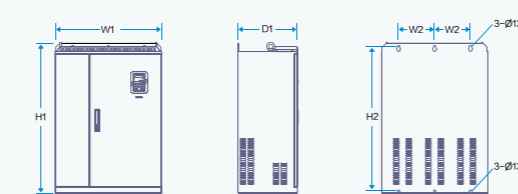

- 3-phase 220VAC Series  
Flange Mounting for 0.75-55kW Inverters

0.75-7.5kW Flange mounting installation diagram

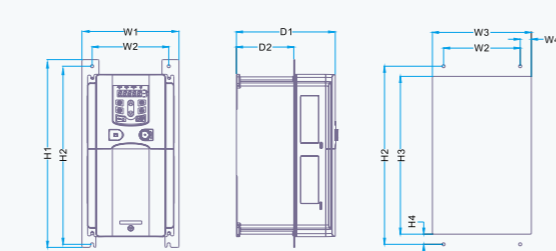

11-15kW Flange mounting installation diagram

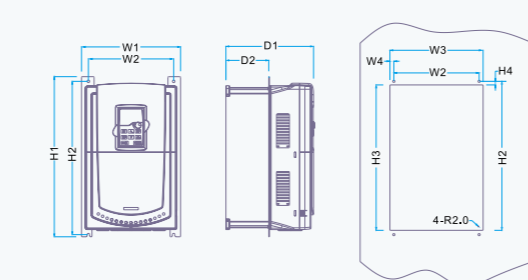

18-55kW Flange mounting installation diagram

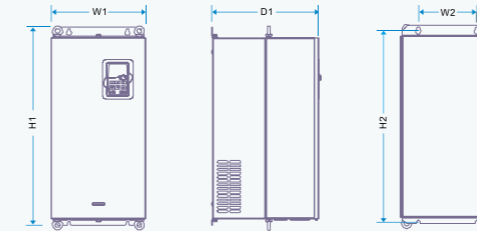

- 3-phase 380VAC Series  
Flange Mounting for 0.75-200kW Inverters

0.75-15kW Flange mounting Installation diagram

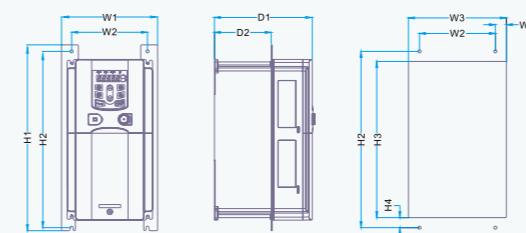

18.5-30kW Flange mounting Installation diagram

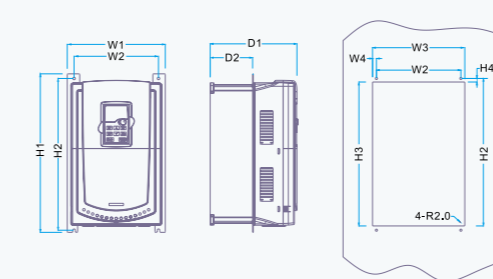

37-110kW Flange mounting Installation diagram

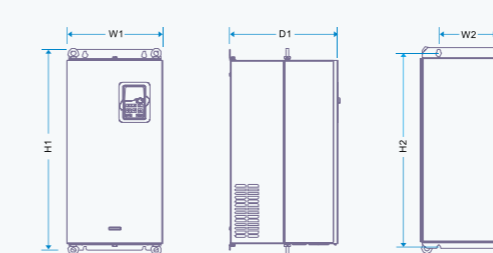

132-200kW Flange mounting Installation diagram

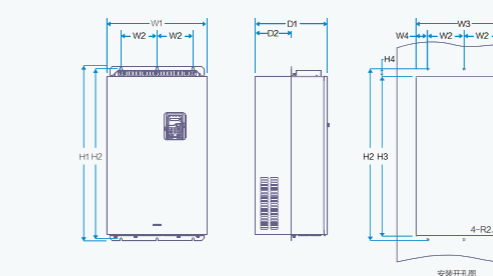

- Floor Mounting for 200-500kW Inverters

220-315kW Floor mounting Installation diagram

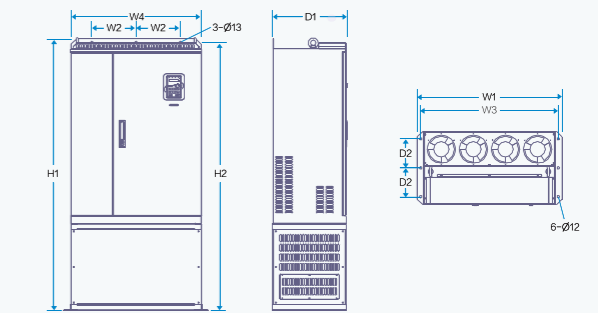

350-500kW Floor mounting Installation diagram

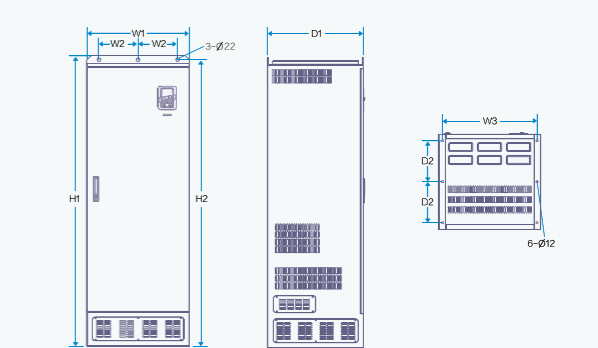

- Dimension for Keyboard

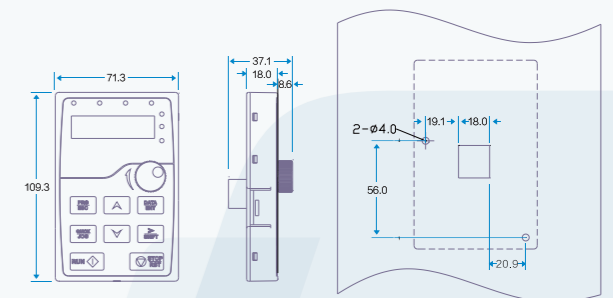

# Optional Parts

## • Flange Mounting Panel

Needed for 0.75G-30G//37P inverters.  
Not needed for 37G/40P-200G//220P inverters.



## • Installation bracket for the keypad

Installation bracket or M3 screw can be used in the installation of external keypad.  
The bracket of 0.75G-30G//37P inverters is standard.  
The bracket of 37G/40P-500G inverters is optional



## • LCD keypad

10 rows of DH displaying  
Compatible with the LED keypad



## • Filters

Inverter model	input filter	output filter	
GD200A 3-phase 380VAC Series	G:0.7—2.2KW	FLT-P04006L-B	FLT-L04006L-B
	G:4—5.5KWP:5.5—7.5KW	FLT-P04016L-B	FLT-L04016L-B
	G:7.5—11KW P:11—15KW	FLT-P04032L-B	FLT-L04032L-B
	G:15—18KW P:18—22KW	FLT-P04045L-B	FLT-L04045L-B
	G:22—30KW P:30—37KW	FLT-P04065L-B	FLT-L04065L-B
	G:37—45KW P:45—55KW	FLT-P04100L-B	FLT-L04100L-B
	G:55—75KW P:75—90KW	FLT-P04150L-B	FLT-L04150L-B
	G:90KW P:110KW	FLT-P04200L-B	FLT-L04200L-B
	G:110—132KW P:132—160KW	FLT-P04250L-B	FLT-L04250L-B
	G:160—200KW P:185—220KW	FLT-P04400L-B	FLT-L04400L-B
	G:220—280KW P:250—315KW	FLT-P04600L-B	FLT-L04600L-B
	G:315—400KW P:350—400KW	FLT-P04800L-B	FLT-L04800L-B
	G:500KW	FLT-P041000L-B	FLT-L041000L-B

Remarks: C2 standard can be achieved of select above external filters

## • Installation Base

Only optional in 220G/250P-315G/350P inverters .Its bases can be built in an input AC (or DC) reactor or an output AC reactor



## • Heat-releasing Hole

Inverter needs to derate when selecting a cover Consult with the INVT technicians for the detailed information.



## • AC single-phase 220V input auxiliary power supply

For more convenient debugging

## • Reactor

The inverters of 37G/45P and above can be connected with external DC reactor. The reactor can improve the power factor and avoid damage to the rectifier bridge caused by overcurrent and damage to the rectifier circuit by harmonic

Inverter model	Input reactor	DC reactor	Output reactor
GD200A-0R7G-4	ACL2-1R5-4	/	OCL2-1R5-4
GD200A-1R5G-4	ACL2-1R5-4	/	OCL2-1R5-4
GD200A-2R2G-4	ACL2-2R2-4	/	OCL2-2R2-4
GD200A-004G/5R5P-4	ACL2-004-4	/	OCL2-004-4
GD200A-5R5G/7R5P-4	ACL2-5R5-4	/	OCL2-5R5-4
GD200A-7R5G/011P-4	ACL2-7R5-4	/	OCL2-7R5-4
GD200A-011G/015P-4	ACL2-011-4	/	OCL2-011-4
GD200A-015G/018P-4	ACL2-015-4	/	OCL2-015-4
GD200A-018G/022P-4	ACL2-018-4	/	OCL2-018-4
GD200A-022G/030P-4	ACL2-022-4	/	OCL2-022-4
GD200A-030G/037P-4	ACL2-030-4	/	OCL2-030-4
GD200A-037G/045P-4	ACL2-037-4	DCL2-037-4	OCL2-037-4
GD200A-045G/055P-4	ACL2-045-4	DCL2-045-4	OCL2-045-4
GD200A-055G/075P-4	ACL2-055-4	DCL2-055-4	OCL2-055-4
GD200A-075G/090P-4	ACL2-075-4	DCL2-075-4	OCL2-075-4
GD200A-090G/110P-4	ACL2-090-4	DCL2-090-4	OCL2-090-4
GD200A-110G/132P-4	ACL2-110-4	DCL2-110-4	OCL2-110-4
GD200A-132G/160P-4	ACL2-132-4	DCL2-132-4	OCL2-132-4
GD200A-160G/185P-4	ACL2-160-4	DCL2-160-4	OCL2-160-4
GD200A-185G/200P-4	ACL2-200-4	DCL2-200-4	OCL2-200-4
GD200A-200G/220P-4	ACL2-200-4	DCL2-200-4	OCL2-200-4
GD200A-220G/250P-4	ACL2-250-4	DCL2-250-4	OCL2-250-4
GD200A-250G/280P-4	ACL2-250-4	DCL2-250-4	OCL2-250-4
GD200A-280G/315P-4	ACL2-280-4	DCL2-280-4	OCL2-280-4
GD200A-315G/350P-4	ACL2-315-4	DCL2-315-4	OCL2-315-4
GD200A-350G/400P-4	standard configuration	DCL2-350-4	OCL2-350-4
GD200A-400G-4	standard configuration	DCL2-400-4	OCL2-400-4
GD200A-500G-4	standard configuration	DCL2-500-4	OCL2-500-4

• Braking system

The power of 30G/37P(including) for GD200A inverters built-in braking unit, and 37G/45P(including) inverters need external braking unit; please choosing the resistor and power of braking resistor for site situation(require of braking torque and amount).

Braking resistor can increase braking torque of inverter , In the table it designs the resistor power according to 100%braking torque,10%braking count,50% braking count,80% braking count; and customers can choose braking system according to specific process and work condition.

Inverter model	braking unit model	100%braking torque fit braking resisters(Ω)	power of braking resister(kW) (10% braking count)	power of braking resister(kW) (50% braking count)	power of braking resister(kW) (80% braking count)	allowing minimum braking resister(Ω)	
GD200A-0R7G-4	built-in braking unit	653	0.1	0.6	0.9	240	
GD200A-1R5G-4		326	0.23	1.1	1.8	170	
GD200A-2R2G-4		222	0.33	1.7	2.6	130	
GD200A-004G/5R5P-4		122	0.6	3	4.8	80	
GD200A-5R5G/7R5P-4		89	0.75	4.1	6.6	60	
GD200A-7R5G/011P-4		65	1.1	5.6	9	47	
GD200A-011G/015P-4		44	1.7	8.3	13.2	31	
GD200A-015G/018P-4		32	2	11	18	23	
GD200A-018G/022P-4		27	3	14	22	19	
GD200A-022G/030P-4		22	3	17	26	17	
GD200A-030G/037P-4		16	5	23	36	17	
GD200A-037G/045P-4		DBU100H-060-4	13	6	28	44	11.7
GD200A-045G/055P-4		DBU100H-110-4	10	7	34	54	6.4
GD200A-055G/075P-4	8		8	41	66		
GD200A-075G/090P-4	6.5		11	56	90		
GD200A-090G/110P-4	DBU100H-160-4	5.4	14	68	108	4.4	
GD200A-110G/132P-4		4.5	17	83	132		
GD200A-132G/160P-4	DBU100H-220-4	3.7	20	99	158	3.2	
GD200A-160G/185P-4	DBU100H-320-4	3.1	24	120	192	2.2	
GD200A-185G/200P-4		2.8	28	139	222		
GD200A-200G/220P-4		2.5	30	150	240		
GD200A-220G/250P-4	DBU100H-400-4	2.2	33	165	264	1.8	
GD200A-250G/280P-4		2.0	38	188	300		
GD200A-280G/315P-4	Two DBU100H-320-4	3.6*2	21*2	105*2	168*2	2.2*2	
GD200A-315G/350P-4		3.2*2	24*2	118*2	189*2		
GD200A-350G/400P-4		2.8*2	27*2	132*2	210*2		
GD200A-400G-4	Two DBU100H-400-4	2.4*2	30*2	150*2	240*2	1.8*2	
GD200A-500G-4		2*2	38*2	186*2	300*2		

# Sales Network



- INVT Sales & Service in 9 countries: Russia, India, Thailand, UAE, Italy, UK, Germany, Australia, Mexico
- Sales and Service Partners in 57 countries





*Your Trusted Industry Automation Solution Provider*



Service line:86-755-86312859 E-mail:overseas@invt.com.cn

**SHENZHEN INVT ELECTRIC CO., LTD.**

No.4 Building, Gaofa Scientific Industrial Park, Longjing, Nanshan District, Shenzhen, China

- |                               |  |                                       |                            |                                   |
|-------------------------------|--|---------------------------------------|----------------------------|-----------------------------------|
| <b>Industrial Automation:</b> | • Frequency Inverter                         | • Servo & Motion Control              | • Motor & Electric Spindle | • PLC                             |
|                               | • HMI  | • Intelligent Elevator Control System | • Traction Drive           |                                   |
| <b>Electric Power:</b>        | • SVG  | • Solar Inverter                      | • UPS                      | • Online Energy Management System |
|                               | • New Energy Vehicle Electric Control System |                                       |                            |                                   |

INVT Copyright.  
Information may be subject to change without notice during product improving.

Y5/1-07V1.0